

156-3575

MULTIPHASE EXCITER
MODEL 10A

INSTRUCTION MANUAL

CENTRAL ELECTRONICS, INC.
1247 West Belmont Avenue
Chicago 13, Illinois

CONDENSED OPERATING INSTRUCTIONS FOR MULTIPHASE EXCITER MODEL 10A

Insert proper pair of plug in coils for band desired. Set VFO-XTAL switch to proper position. Turn RED AM carrier knob fully clockwise. Turn OPERATION selector to manual and tune MIXER and AMPLIFIER for maximum output as indicated on a scope, receiver "3" meter or antenna meter. Connect antenna or linear amplifier to the 52 ohm RF output screw terminals. The bottom terminal is ground.

TO OPERATE SINGLE SIDEBAND

Set the MODULATION selector to one of the sideband positions (SB1 or SB2). Turn the OPERATION selector to manual. Adjust the CARRIER knobs (AM and FM) for minimum output as indicated on an oscilloscope or receiver "5" meter. Adjust the SPEECH LEVEL control. (Between 10 and 12 o'clock depending upon microphone gain.) Talk into the microphone and your on SSB :

TO OPERATE AM

Place the MODULATION selector in the AM position. Leave the FM CARRIER knob in the balanced-out condition. Adjust the red AM CARRIER knob until maximum carrier output is reached. Then reduce the AM CARRIER level to one half of the maximum value on the scope or to one half the maximum antenna current. Adjust the SPEECH LEVEL until modulation peaks just reach the maximum output value. Too little or too much carrier will make the AM transmission sound distorted.

TO OPERATE FM (Narrow band phase modulation)

Turn modulation selector to FM position. Leave the AM CARRIER knob in the balanced-out condition. Adjust the black FM CARRIER knob to nearly full output. Adjust the SPEECH LEVEL control so that the modulation peaks do not exceed the carrier.

TO OPERATE CW

Turn the SPEECH LEVEL off. Place the OPERATION selector on manual. Turn the AM CARRIER to nearly maximum output. Plug key in jack on rear of chassis.

TO USE THE VOICE CONTROL CIRCUIT (VOX)

Connect the receiver speaker to the exciter as shown in the circuit diagram. The resistor across 1 and 2 on the rear terminal strip should be about three times the speaker voice coil impedance and rated at twice the power output. The extra contacts on 8, 9 and 10 may be used to operate an antenna relay, receiver silencing circuits, etc. With the OPERATION selector in VOX position talk into the microphone and adjust the VOX sensitivity control on the rear for proper operation.

Multiphase Exciter Model 10A

2/2/53 Mod.

10A PRELIMINARY ALIGNMENT INSTRUCTIONS

THE FOLLOWING IS RECOMMENDED FOR UNITS CONSTRUCTED FROM KITS

Check for "B" shorts with an ohmmeter before power is applied.

Before plate voltage is applied, the 6AG7 grid bias should be checked. This should be done by removing the 5U4G rectifier tube. With the relay in the normal position, the reading at Pin #4 of the 6AG7 should be -100V DC plus or minus 10% measured with a VTVM. When the relay is operated by hand, there should be approx. -11V DC at this point. After the 5U4G is inserted, the operating bias should be -10.5V DC obtained from the voltage divider R47 and R48.

Insert the 5U4G rectifier and apply power. Check "B" voltages in accordance with the chart on the circuit diagram, with the OPERATION switch on MANUAL.

Preliminary rough alignment of the slug-tuned coils. If a grid dipper is available the coils should be aligned to the frequencies indicated on the Alignment Data Chart, Fig. B. If no dipper is available they should be set as follows BEFORE POWER IS APPLIED:

- #1 RED 3/16"
- #2 GREEN 3/16"
- #3 WHITE 1/16"
- #4 BLACK 1/2"
- #5 BLUE 1/2"
- #6 ORANGE 5/16"
- #7 YELLOW 5/16"



The Audio Balance controls should be set in approximately mid-position.

Proceed with the General Alignment Instructions.

10A GENERAL ALIGNMENT PROCEDURE

The front panel controls should be set as follows:

SPEECH LEVEL, completely counterclockwise.
MODULATION switch, Sideband 1.
AM CARRIER, Mid position.
PM CARRIER, completely clockwise.
VFO - XTAL switch, in correct position.
OPERATION switch, MANUAL

Plug in the proper MIXER and AMPLIFIER coils, and adjust the tuning controls to the desired output frequency.

Refer to Fig. A. Connect a non-inductive load resistor of about 50 ohms, 10 watts, to the exciter RF output terminals. This resistor may consist of several one or two watt composition resistors in parallel to provide the required resistance and dissipation. For example, ten one-watt 500 ohm or five 250 ohm two-watt resistors may be used.

Connect an oscilloscope, lightly coupled, to the RF output.

If available, an RF vacuum tube voltmeter having a 25 volt range should be connected to the RF output.

Tune the crystal oscillator tank circuit until the signal is heard in a receiver tuned to 9000 kc. If a receiver or grid dipper is not available a DC voltmeter connected to the cathode, Pin #8, of the 12BH7 oscillator tube will serve as an indicator. When the xtal is not oscillating the reading will be about 10 V DC. When the stage is oscillating and L1 is tuned for maximum the reading will be approx. 20 V DC. Turn the power switch on and off several times to make certain the crystal oscillates reliably. If necessary readjust L1 for proper operation.

At this point it should be possible to hear a signal on the output frequency with the receiver operating near full sensitivity (AVC on) provided that the VFO or frequency conversion crystal is operating. The receiver antenna should be lightly coupled to the exciter output terminals. Refer to Fig. B. Adjust L2, L3, L4, L5 and the MIXER and AMPLIFIER tuning condensers for maximum output. As maximum output is reached, it may be necessary to reduce the carrier by adjusting the PM carrier control to provide slightly less output. This will prevent overloading the 6AG7 amplifier. Now adjust both carrier controls for minimum carrier output. Minimum output may not necessarily occur at the center of the scale due to stray circuit capacities etc. Next unbalance the PM control a slight amount to give about one fourth the maximum output and peak L2 through L5 again. Now adjust both carrier controls again for minimum carrier output. It will probably be found that the carrier controls will null at slightly different settings than those obtained previously. Turn the PM control completely clockwise and see if the crystal remains in oscillation. Unbalancing this control places an additional load on the oscillator and may pull it out of oscillation. If this occurs, it will be necessary to vary the adjustment of L1 until reliable operation is assured.

When L2 (green) is mounted as close as possible to L1 (red), the RF voltage from the arms of the carrier pots to ground will be approximately equal when the carrier is balanced out. If desired, this may be checked with an RF vacuum tube voltmeter.

Adjustment of L6 and L7. These trap circuits need be adjusted only when 20 meter operation is contemplated. Their purpose is to reduce radiation of the third harmonic generated in the mixer of the heterodyning crystal oscillator or VFO operating in the range of 5000 to 5350 kc. With the 20 meter coils in place, the SPEECH LEVEL turned off, carrier balanced out, and OPERATION control in the manual position, it will be possible to find output with an oscilloscope or receiver when the MIXER and AMPLIFIER are tuned to approx. 15 mc. Adjust these tuning controls for maximum output using a crystal or VFO at approx. 5150 kc. If no crystal is available in this range, one at approx. 3850 kc. will provide enough 4th harmonic output for alignment of the traps. When a crystal is used, L7 should be tuned for minimum 15,450 kc. output. When a VFO is used, only L6 will provide a null at 15.9 mc.

The VFO output should be advanced up to the point where additional coupling will not increase the exciter output. Over-injection to the mixer will generate harmonics of the VFO frequency that can appear in the output as spurious radiation.

Although the 3rd harmonic output may be only a few percent of the total, it will be amplified by the Mixer and Amplifier stages resulting in a sizeable output. With the trap circuits properly aligned, the power output at 15 mc. will be less than 10% of that normally produced at 14 mc., even though the Mixer and Amplifier are tuned to 15 mc. When the Mixer and Amplifier are peaked on 14 mc., the 15 mc. signal will be down in excess of 50 db. This is adequate rejection when the exciter alone is used to feed an antenna. The addition of a properly tuned linear amplifier stage will increase the rejection of 15 mc. to at least 70 to 80 db. down.

SIDEBAND SUPPRESSION ADJUSTMENT

Before proceeding with the Single Sideband adjustments, it is recommended that the operator familiarise himself with the illustrations of the oscilloscope patterns shown in this manual. The ultimate objective in the single sideband alignment is to obtain a pattern containing a minimum amount of ripple when a pure sine wave is applied to the microphone input. These adjustments should preferably be made at less than full output, to prevent amplifier overloading, which might "wipe off" the small modulation ripple.

A low distortion audio oscillator (less than 1%) set to approx. 1,225 cycles, with an output level between .005 and .05 volts should be connected to the microphone jack. CAUTION: If a voltage in excess of .075 is applied to the Mic. input the speech amplifier will overload and it will be impossible to adjust the exciter properly.

Adjust both CARRIER pots for minimum carrier output. Advance the SPEECH LEVEL control until about half of maximum output is obtained on the oscilloscope. At this point a fair amount of ripple will be observed on the output wave. Adjust the Audio Balance controls for MINIMUM ripple. Now switch from Sideband 1 to Sideband 2 and observe the ripple in each. If the amount of ripple is not equal, vary the adjustment slightly on L2 until the displays are identical in either sideband position. However, each time L2 is tuned, it will be necessary to re-balance both carrier controls for minimum. It will also be necessary to readjust the Audio Balance controls again.

It is possible to make these sideband suppression adjustments using a receiver in place of an oscilloscope. Turn the AVO on, the BFO off, and remove the antenna to prevent receiver overload. Now tune in the signal. Minimum modulation heard in the loudspeaker corresponds to minimum modulation of the R.F. envelope. Adjust as described in the previous paragraph.

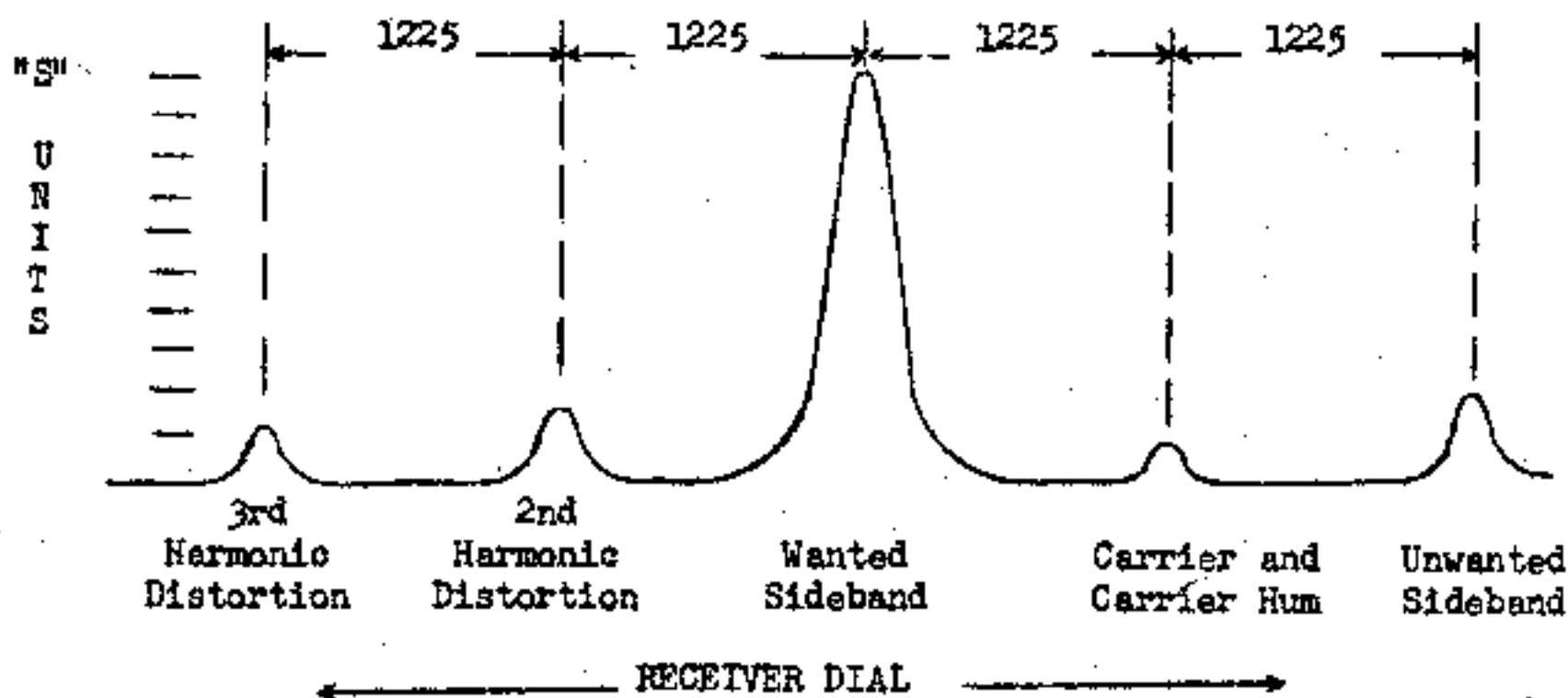

It is possible to obtain an almost ripple-free pattern in one sideband at the expense of degradation of the other. Under this condition the suppression of the better sideband will be about 45 db., while the other is only 35 db. down. The object is to have them both equal, approximately 40 db. down.

If a deep modulation ripple is noticed on both sideband positions (with carrier balanced out), one side of the audio phase shift circuit is probably operating improperly. Check the Audio Balance controls adjustment, the 12AT7 (B) modulator tube, sideband switching circuit, or the phase shift network.

After the alignment has been completed, be sure to tighten the #6 lock-nuts on the iron core slugs.



Good SSB Signal
Pure Tone Input



SSB Signal, Tone Input
Poor Sideband Suppression

1. Improper RF phasing (L2)
2. Improper AF balance (R18-15A)
3. Balanced Mod detuned (L3)

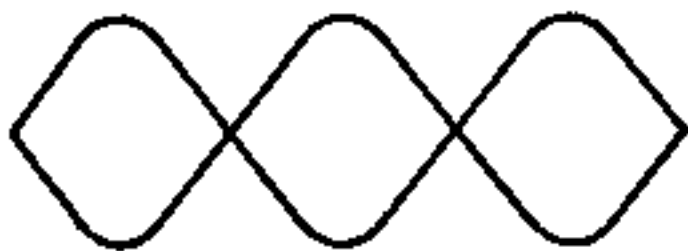

SSB SIGNAL, TONE INPUT
WITH PROPER CARRIER INSERTED
100% MODULATED



SSB SIGNAL, TONE INPUT
AUDIO DISTORTION
EXCESSIVE AUDIO INPUT
EXCESSIVE DISTORTION IN
AUDIO OSCILLATOR



SSB SIGNAL, TONE INPUT
INSUFFICIENT 9000 kc. XTAL
OSCILLATOR OUTPUT

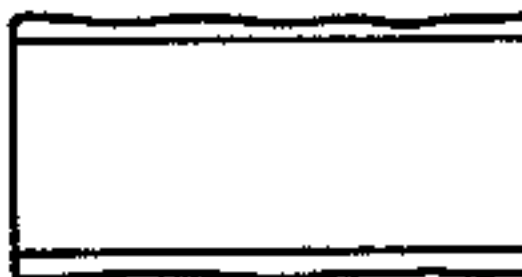

GOOD SSB SIGNAL, TONE
INPUT WITH SMALL PER-
CENT OF SPURIOUS RADI-
TION (RF)

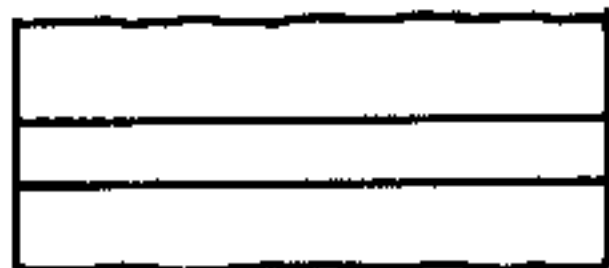

GOOD SSB SIGNAL, TONE INPUT
WITH LARGE PERCENT OF
SPURIOUS RF RADIATION



SSB WITH CARRIER, TONE
INPUT IMPROPER AMPLIFIER
BIAS

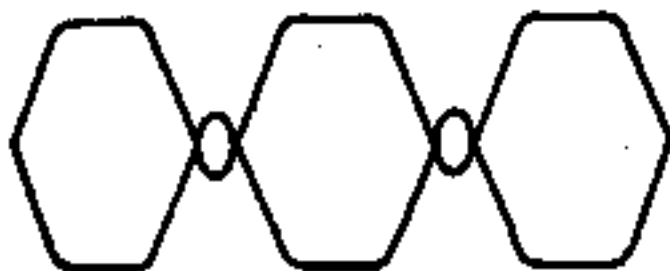

DOUBLE SIDEBAND WITH CARRIER
EXCESSIVE TONE MODULATION
WITH AUDIO PEAKS SQUARING OFF



SSB SIGNAL, TONE INPUT
BALANCED MOD DETUNED (L3)

M68A-108-9MX
2/22/60
Alignment of 10-20

P230A
108 MXA
109 MX

P-5



SSB WITH CARRIER, TONE INPUT.
 1. EXCESSIVE AUDIO SIGNAL
 2. INSUFFICIENT ANT. LOADING



DERC DOUBLE SIDEBAND REDUCED
 CARRIER OBTAINED BY REDUCING
 CARRIER LEVEL AND INCREASING
 AUDIO INPUT LEVEL.

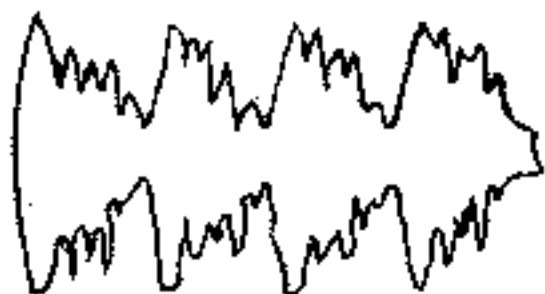

GOOD SSB SIGNAL VOICE INPUT



SSB SIGNAL, VOICE INPUT. SQUARING
 AUDIO PEAKS. EXCESSIVE SPEECH GAIN



SSB SIGNAL, TONE INPUT
 AMPLIFIER OVERLOADING DUE TO
 EXCESSIVE AF OR RF DRIVE. NOTE
 THE LACK OF SMALL RIPPLE ON
 ENVELOPE



DOUBLE SIDEBAND AM WITH CARRIER
 100% MODULATED



TWO TONE LINEARITY TEST OBTAINED
 WITH SINGLE TONE INPUT, WITH CARRIER
 BALANCED OUT ON AM

FOR ADDITIONAL REFERENCE THE
 FOLLOWING IS RECOMMENDED:

SUGAR COATED LINEAR AMPLIFIER
 THEORY - OCTOBER '51 QST

HOW TO TEST AND ALIGN A LINEAR
 AMPLIFIER - MAY '52 QST

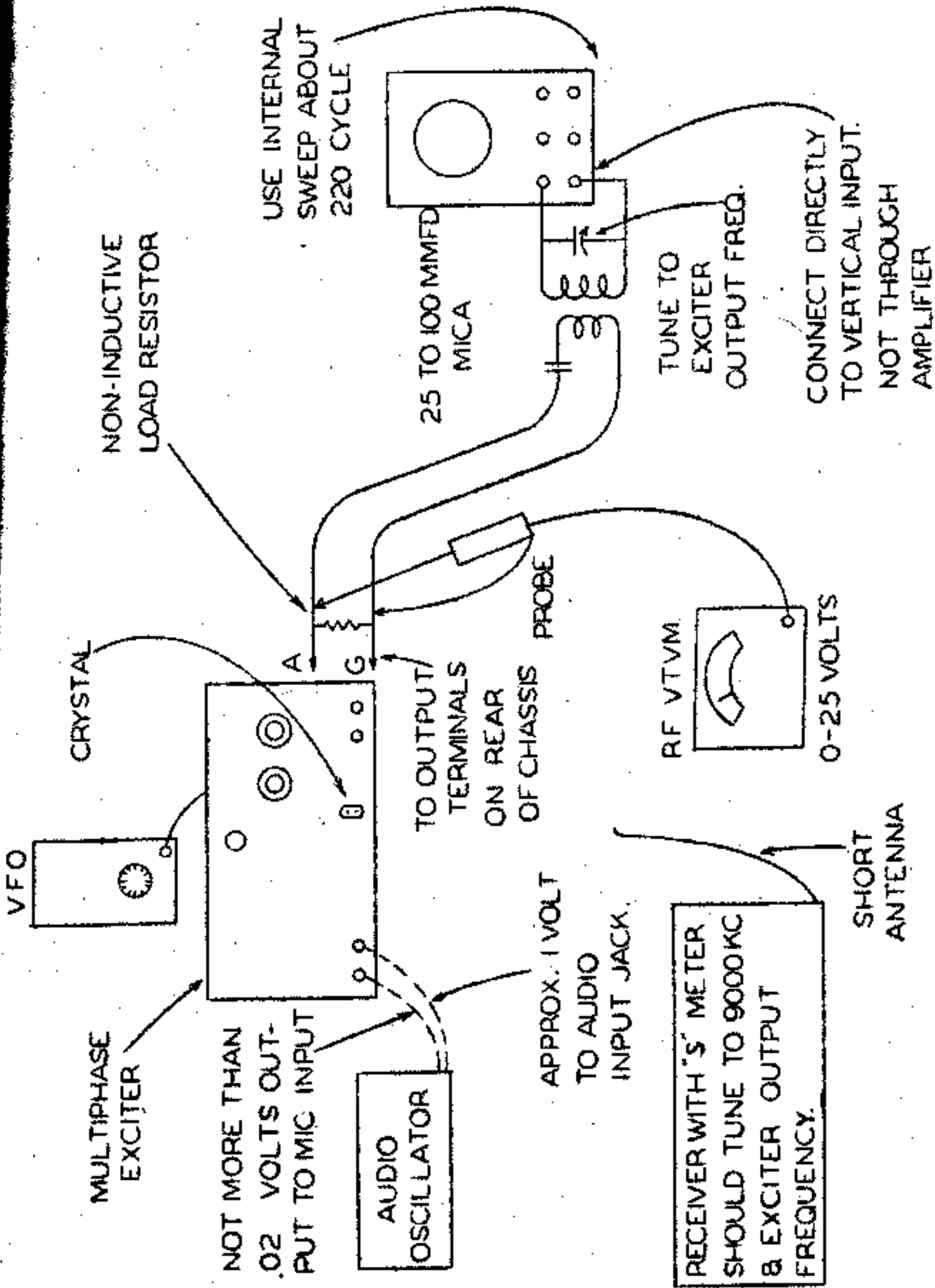
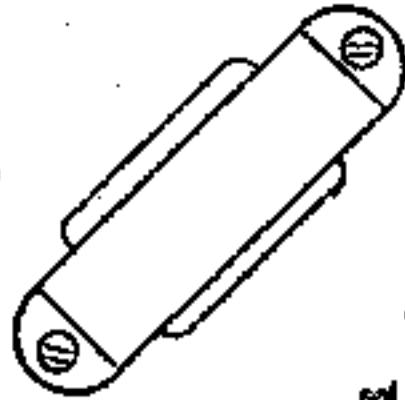

FIG. A

AUDIO BALANCE

Adjust for minimum unwanted sideband ripple with 1225 cycle tone input.



AUDIO BALANCE

Adjust same as above.

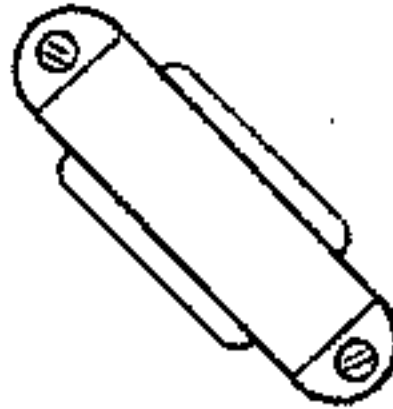

5. BLUE 9000 kc. FILTER

Adjust for max output with PM control unbalanced to give nearly full output.



7. YELLOW 15 mc. TRAP

Use XTAL at approx. 5150 kc. or 3850 kc. Adjust for minimum 15 mc. output with 20 meter coils inserted, and mixer and amp tuned for max 15 mc. output.

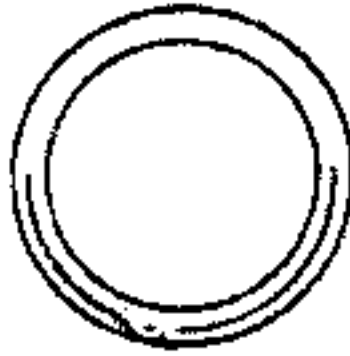

4. BLACK 9000 kc. FILTER

Adjust for max output with PM control unbalanced to give nearly full output.



6. ORANGE 15.9 mc. TRAP

Adjust in same manner as yellow trap.



1. RED XTAL OSC.

5000 kc.

Peak for max output then back off to insure reliable crystal operation. PM control fully clockwise.



2. GREEN 90° RF PHASE SHIFT

5000 kc.

Peak for max output with PM control unbalanced to give nearly full output. Afterward, adjust for equal sideband suppression with audio osc to a/c input.



3. WHITE BALANCED MODULATOR

9000 kc.

Adjust for max output with PM control unbalanced to give nearly full output.



FIG 8

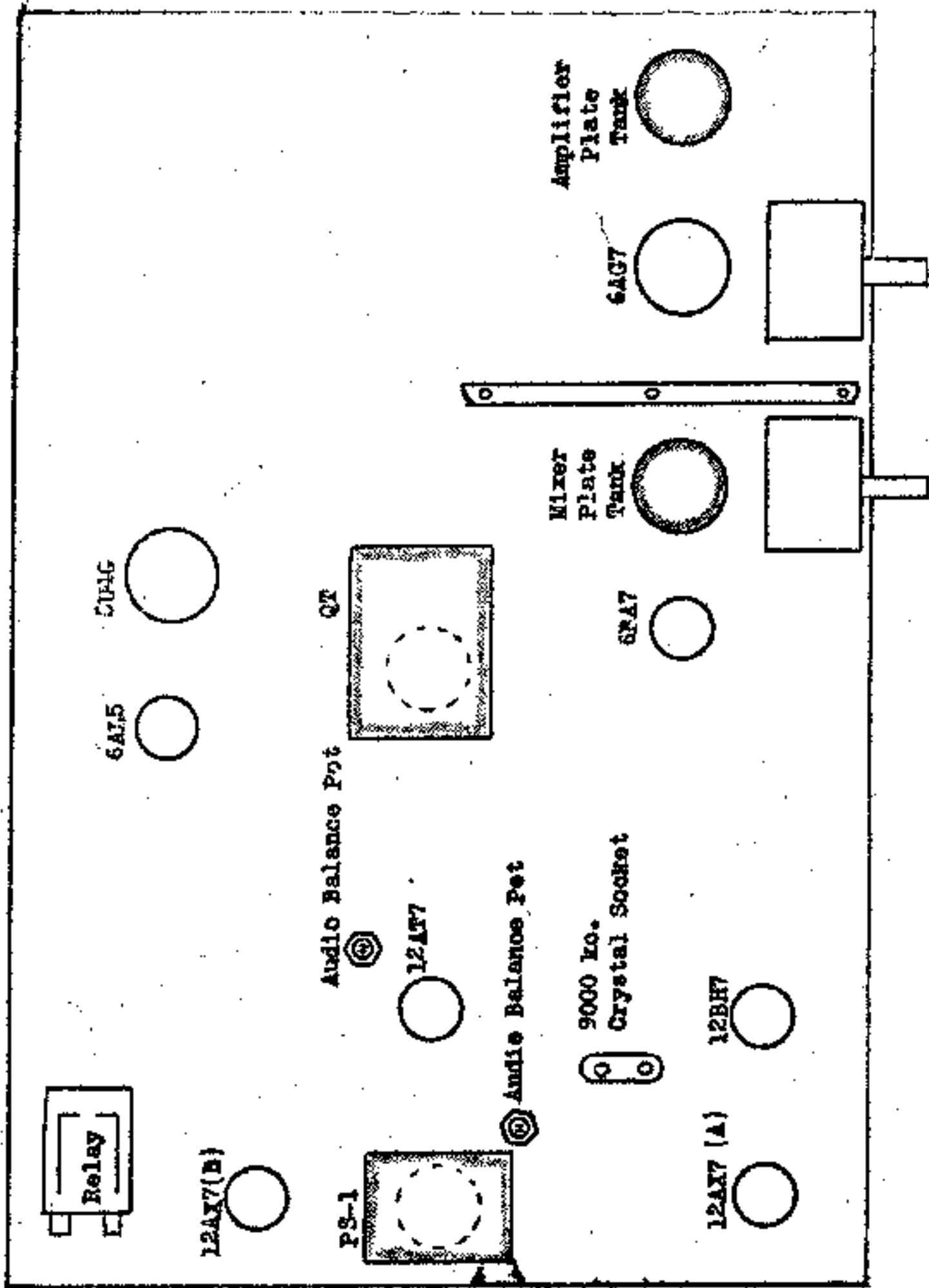

TUBE PLACEMENT CHART
 MULTIPHASE EXCITER MOD 10A
 Central Electronics, Inc.
 2125 W. Giddings Street,
 Chicago 25, Illinois U.S.A.

**MODIFYING THE BC-457, 458 and 459 AS A VFO FOR THE
MODEL 10A MULTIPHASE EXCITER**

EXTERNAL CONNECTIONS

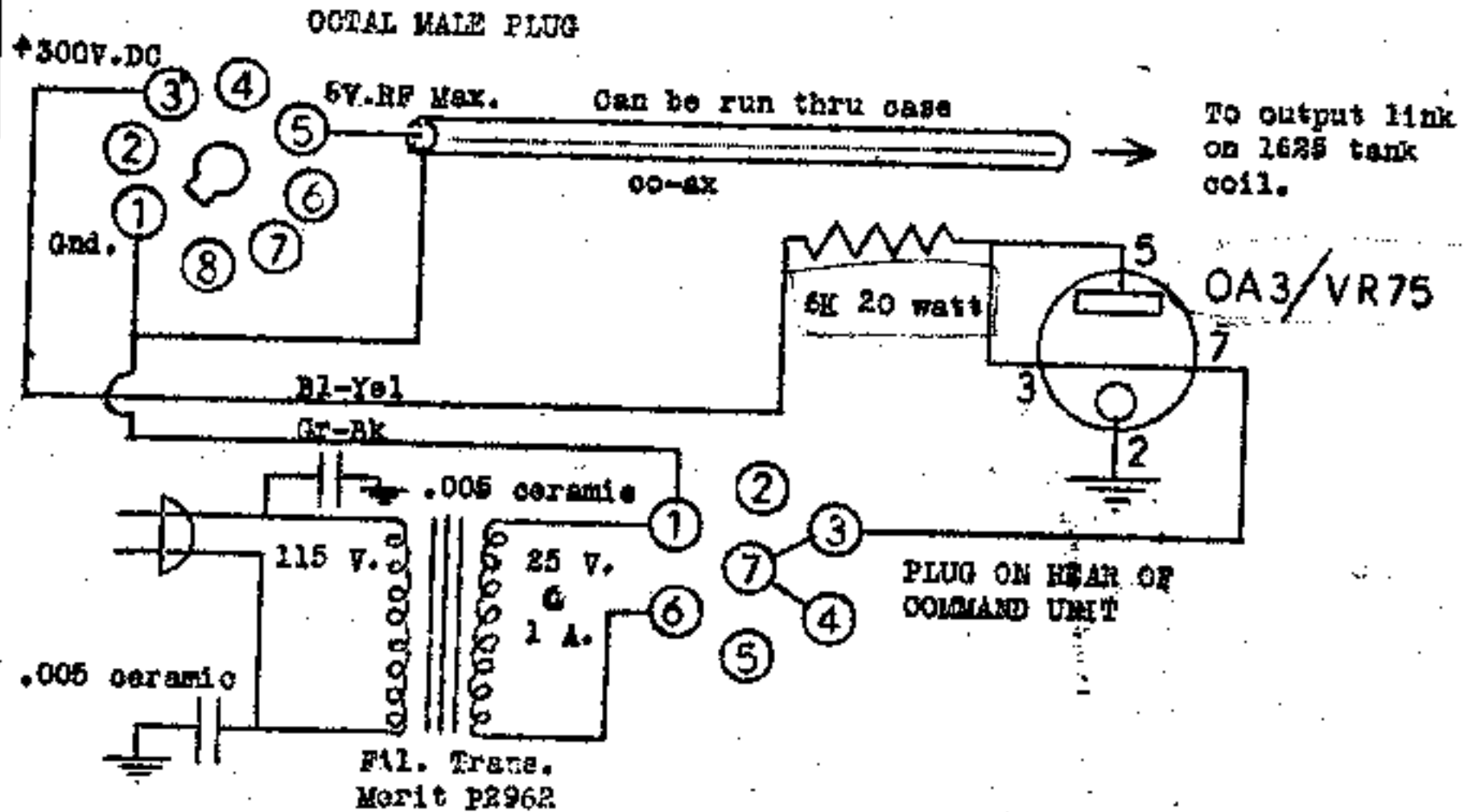

INTERNAL CHANGES

The contacts on K53 relay should be closed by jumpers or a wedge in the armature. This applies B plus to the oscillator and also completes the cathode to ground circuit on the 1625 stage. The cathode lead of the paralleled 1625 should be opened to reduce the current drain. Only one 1625 is necessary for proper operation.

The leads going to pin #8 of the eye tube VT-138 should be disconnected.

The antenna loading coil and antenna relay are not used, and can be removed. The co-ax cable to the 10A exciter can be attached directly to the output link of the 1625 final tank coil.

Plate voltage for the VFO is supplied by the 10A exciter through an octal socket on the rear. The RF input to the mixer in the exciter also appears on this socket. It is suggested that the filament transformer, VR75 and its dropping resistor be mounted on a shelf or a chassis attached to the rear of the command unit.

The electrical connections for the external wiring are shown above.

The antenna coupling adjustment on the command unit should be advanced to the point where additional coupling will not increase the exciter output. Over injection to the mixer will generate harmonics of the VFO frequency that can appear in the output as spurious radiation. For 14 mc. operation with a BC-457 a point of critical coupling can be found that will cancel the 3rd harmonic output from the mixer.

USING THE BC-457 FOR 80, 40 AND 20 METER OPERATION

The use of a 1.7 to 2 mc. crystal or VFO for 40 meter operation is not recommended. A fourth harmonic of the injection frequency would be generated in the mixer stage and appear in the mixer output.

If the band-setting capacitors of the BC-457 are decreased in capacity to extend the oscillator tuning range to 5433 kc., the 1625 stage may then be operated as a frequency tripler in the range of 16 to 16.3 mc. by switching in a parallel plate inductor.

Use of the BC-457 for this purpose will alter the original frequency calibration. For those who prefer to retain the original dial calibration and utilize higher oscillator circuit capacity, the use of a BC-458 (5.3 to 7 mc.) is recommended.

MODIFICATION

The changes listed on page TEN should be made first.

1. Remove the antenna loading assembly and window.
2. Cut a metal plate 2 X 5 inches and drill to mount in the four front panel holes that previously held the rotary coil. In the center of this plate drill a $15/32$ inch hole and mount a S.P.S.T. toggle switch.

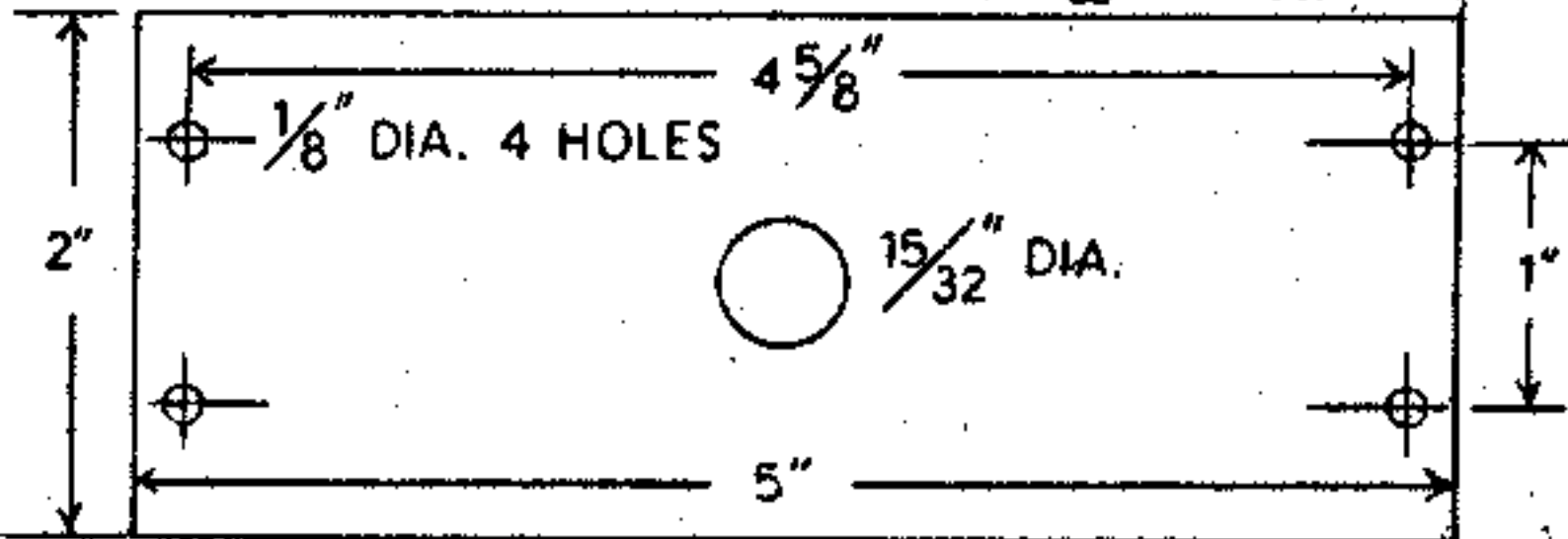

3. Drill four holes in the bottom plate of the unit, about 1 inch in from each corner, and mount four rubber feet to reduce mechanical shock. As an alternative the unit may be set on a sponge rubber pad.
4. Prepare a coil of approx. .375 uh. (5 turns, 1" dia. spaced 8 turns per inch, B&W miniductor #3014) with a $3/4$ inch lead on one end and a $2\frac{1}{2}$ inch lead on the other. Then cut one polystyrene bar at the long end so that the last quarter turn of the coil may be varied as a means of trimming the inductance.
5. Solder a .001 mica capacitor from one terminal of the toggle switch to a ground lug on one of the screws that mount the metal plate. Solder the short end of the miniductor to the other switch terminal. Solder the long lead of the miniductor to the top terminal of the ceramic form, at the junction of the 1625 plate parasitic suppressors.

A circuit diagram of this modification appears on the following page with a parts list of a modification kit offered by CENTRAL ELECTRONICS, INC.

SCHEMATIC

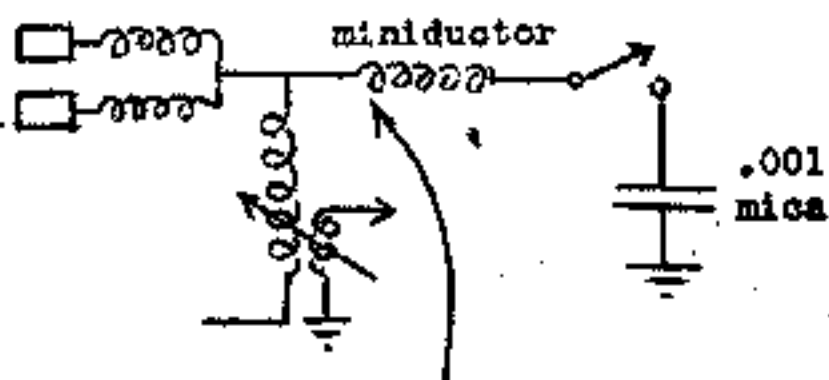

Vary last quarter
turn for maximum
output.

TOP VIEW

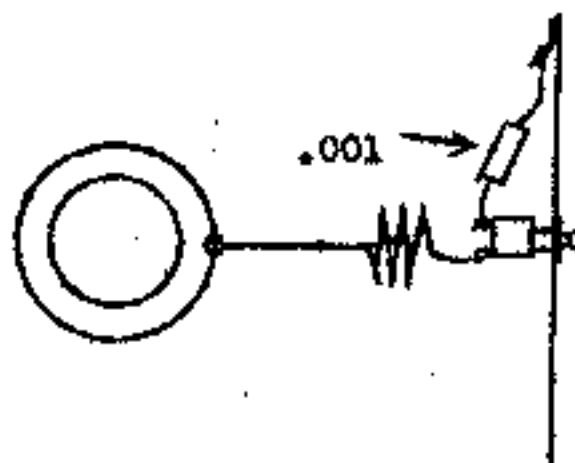

MODIFICATION KIT #40B0457 OR #40B0458 PARTS LIST.

- 1 -- Mounting plate (Drilled as per drawing on page ELEVEN)
- 1 -- Miniductor out to size.
- 4 -- Rubber feet.
- 4 -- Sheet metal screws for mounting feet.
- 1 -- Bristol wrench.
- 1 -- .001 mica 500 volt.
- 1 -- S.P.S.T. toggle switch, washer and nut.
- 4 -- (each) #4-40 Screws, nuts and lockwashers.
- 1 -- Soldering lug.

NOTE: Kit number must be specified when ordering.

PRICE per kit (postpaid) \$1.50

CENTRAL ELECTRONICS, INC.
2125 W. Giddings Street,
Chicago 25, Illinois

ALIGNMENT INSTRUCTIONS

CAUTION: DO not alter original adjustment of two variable iron core slugs.

Plug the VFO into the rear of the Multiphase Exciter.

Place the parallel inductor switch in the off (open) position.

Set your receiver to 7300 kc. with BFO on.

Adjust exciter dials to approximately 7.2 mc. with the 40 meter coils in place and insert carrier with the Operation switch in MANUAL.

Set the dial of the BC-457 about 1/4 inch past the 5.3 mc. mark.

The frequency of the unit is varied by turning the oscillator capacitor which is located in the shield can on top of the unit. Sufficient variation of this capacitor may be obtained by loosening the binder head set screw accessible through a 7/16 inch hole on the right side of the can. Move the oscillator capacitor arm to minimum capacity. (Completely counterclockwise) At this time the VFO signal should be heard in the receiver. If it is not, adjust the small trimmer accessible through the top of the oscillator can until it is.

The amplifier capacitor which is located underneath the chassis is adjusted in the same manner as the above. Peak this capacitor to the oscillator frequency by using the OA3/VR75 as an indicator. Adjust for maximum brilliance.

Now switch in the parallel inductor and vary the spacing of the last quarter turn until maximum output is obtained. (Maximum exciter output or maximum brilliance on the VR tube.) **CAUTION:** Plate voltage is present on coil.

The kit for this modification is #40BC457.

NOTE: If so desired, 7300 kc. may be made to tune at the 5.3 mc. mark on the unit dial by removing the shield can and loosening the bristol set screw to obtain greater variation in the oscillator capacitor. If this is done the same procedure may be necessary on the amplifier capacitor.

USING THE BC-458 FOR 40 METER OPERATION

In this unit the amplifier stage is also operated as a frequency tripler in the range of 16 to 16.3 mc. by switching in a parallel inductor.

It may also be used for operating in the range of approximately 14230 kc. and up without affecting the dial calibration. In this case, 14.3 mc. will occur at 5.3 on the dial, and the rest of the band in the portion below this calibration. It will probably be possible to reach 14200 kc. by merely adjusting the trimmer in the top of the oscillator can. If this does not quite reach, it may be necessary to move the arm on the oscillator and amplifier capacitors slightly clockwise. These changes will affect the calibration a trifle.

The parallel plate inductor for this purpose consists of three turns of #3014 B&W miniductor (8 turns per inch). Break the polystyrene strip so that the last quarter turn may be varied to trim the inductance.

The kit for this modification is #40BC458.

USING THE BC-458 FOR 80, 40 AND 20 METER OPERATION

This conversion is similar to that of the BC-457. In this case the oscillator and amplifier capacitors must be set so that the circuits reach 5000 kc. With the dial set at 5300 kc. It may be necessary to loosen the bristol set screws to obtain this result. This is the most desirable unit to use, inasmuch as the oscillator circuit is operating with nearly full capacity for all three bands.

The kit for this modification is #40BC458.

MULTI-BAND OPERATION OF THE MULTIPHASE EXCITER MODEL 10A

The following chart indicates the injection frequencies required with the 9 mc. master oscillator.

OUTPUT FREQUENCY	INJECTION FREQUENCY
1800 kc. 2000 kc.	7200 kc.* or 10800 kc. = 5400×2 7000 kc.* or 11000 kc. = 5500×2
3500 kc. 3800 kc. 4000 kc.	5500 kc.* or 12500 kc. 6200 kc.* or 12800 kc. 5000 kc.* or 13000 kc.
7000 kc. 7200 kc. 7300 kc.	16000 kc. or 5333.3×3 kc. 16200 kc. or 5400×3 kc. 16300 kc. or 5433.3×3 kc.
14000 kc. 14200 kc. 14300 kc.	5000 kc.* or 23000 kc. 5200 kc.* or 23200 kc. 5300 kc.* or 23300 kc.
21000 kc. 21450 kc.	12000 kc. or 30000 kc. 12450 kc. or 30450 kc.
28000 kc. 28500 kc. 29700 kc.	37000 kc. 10000×3.7 37500 kc. 10000×3.75 38700 kc.

* Injection at these frequencies may be obtained from crystals plugged into the front panel socket.

NOVICE OR C.W. OPERATION ONLY

Break-in CW may be used on the 160, 80 and 40 meter bands with direct frequency crystals. Turn the speech level control OFF, and remove the 9000 kc. crystal. Then plug the 160, 80 or 40 meter crystal into the socket on the front panel and tune the controls to frequency.

Frequency multiplication may be used only when the exciter feeds a high "Q" antenna tuner or power amplifier stage, due to probable radiation of sub-multiple frequencies. It is possible to obtain 80 meter output from 160 meter crystals, 40 meter output from 80 meter crystals, and 20 meter output from 7 mc. or 4.7 mc. crystals

AMPLIFIER PLUG-IN
COIL L-9

PLUG-IN COIL COLOR CODE

160 WHITE 20 GREEN
80 RED 15 BLUE
40 YELLOW 10 SLATE

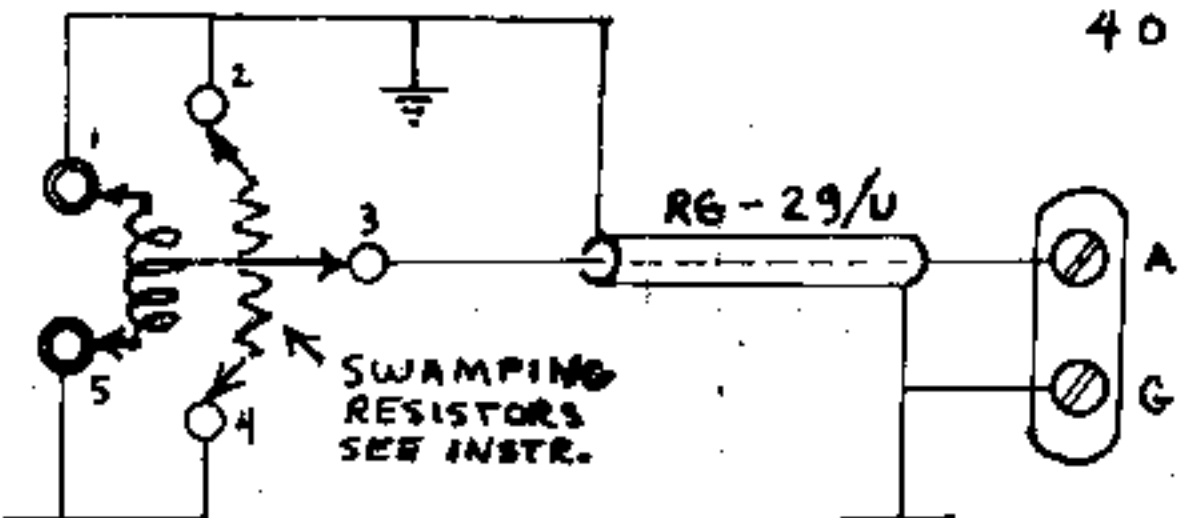

ALL DC AC & RF VOLTAGES TAKEN WITH VTVM*

	1	2	3	4	5	6	7	8	9
12AX7 (A) PREAMP	200	0	1.9	3.15 AC	3.15 AC	130	0	1.4	3.15 AC
12BH7 AF DRIVER MASTER OSC	260	0	10	3.15	3.15	290 ** 50 RF	-11 30 RF	18	3.15 AC
12AT7 AF MODULATOR	290	0	4	3.15	3.15	290	0	4	3.15 AC
6BA7 MIXER	80	-6 DC 8V RF	0	3.15	3.15	0	1.6 RF	0	290 11 RF
6AG7 POWER AMP	0	3.15 AC	300	-19 DC 14 RF	0	295	3.15 AC	300 250 RF	
12AX7 (b) VOICE AMP RELAY CONTROL	240	11	11	3.15 AC	3.15 AC	170	0	1.1	3.15 AC
6AL5 VOICE RECT BIAS RECT	1.0	-100	3.15 AC	3.15 AC	75 AC	0	-0.4		
5U4-G HV RECT.	0	315	0	280 AC	0	280 AC	0	315	

** IF XTAL STOPS OSC, TURN L-2 CLOCKWISE

CENTRAL ELECTRONICS, INC.

2125 W. GIDDINGS ST.
CHICAGO 25, ILLINOIS USA.

5-11-53

ASE EXCITER

*10A-98A

MODEL 10-A'

~~2-11-53~~

IAL 611 AND ABOVE

CORRO 9-14-54

REVISED 9/24/52

12AT7 & R-18

MIXER PLUG-IN
COIL L-8

POWER AMPLIFIER
6AG7

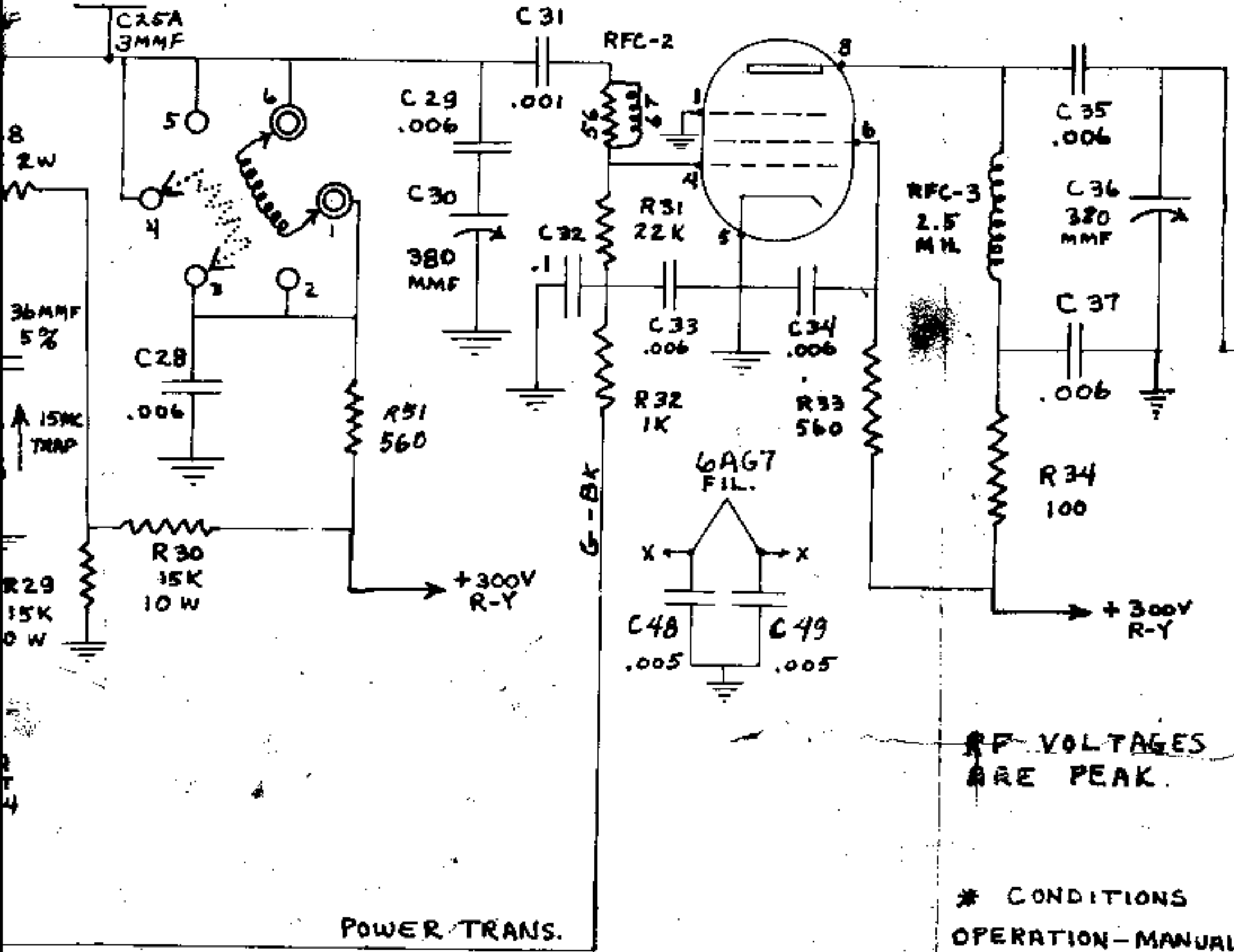

RF VOLTAGES ARE PEAK.

* CONDITIONS
OPERATION - MANUAL
AM CARRIER - MAX
SPEECH LEVEL - OFF
VOX SENS - OFF
RF OUTPUT - 4 MC

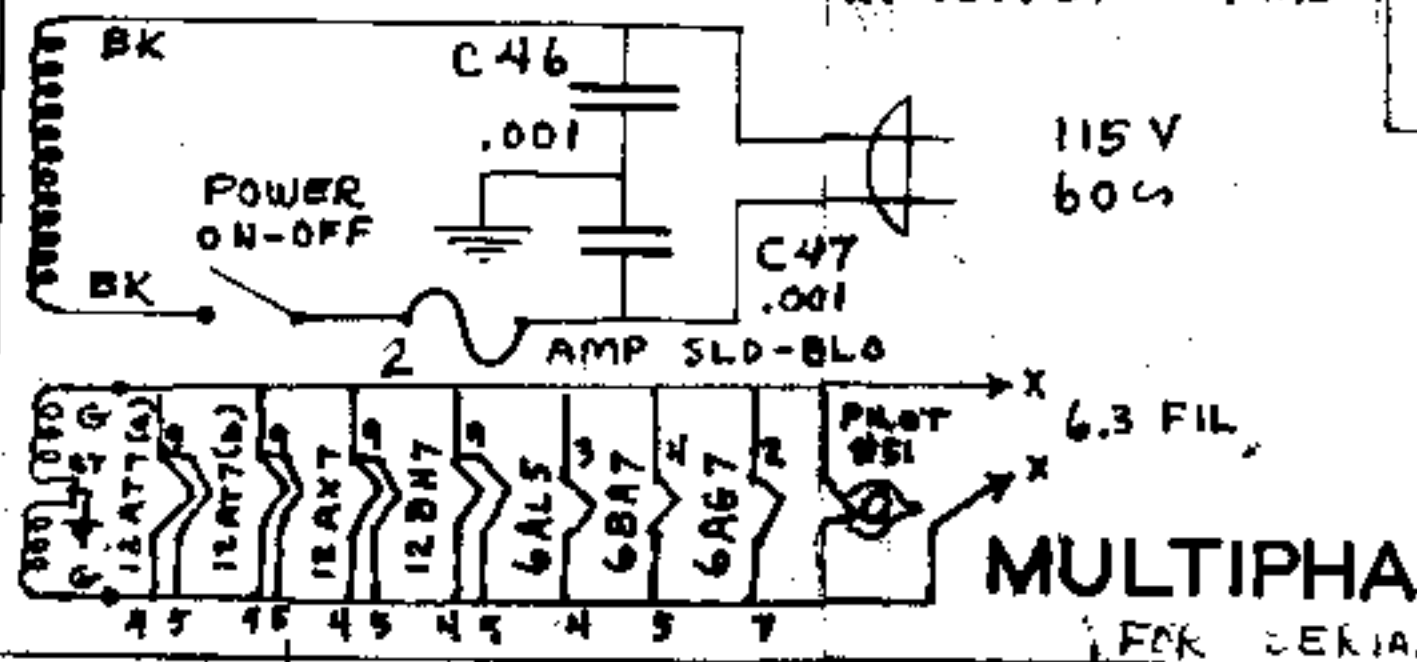
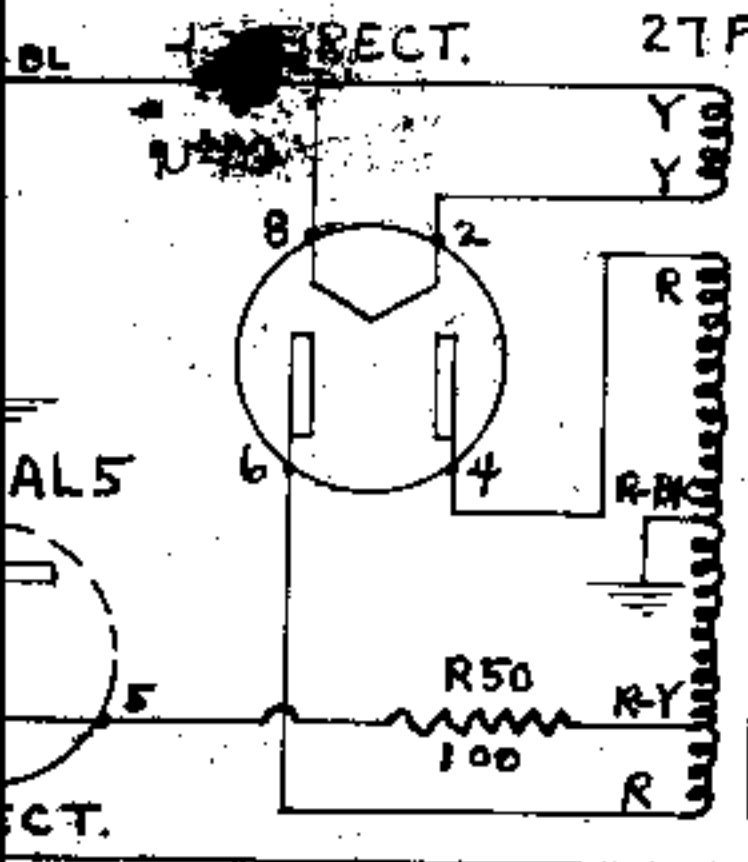

BALANCED MODULATOR
 IN48/IN51 DIODES
 (MATCHED)
 (SET OF 4)

MIXER
 6BA7

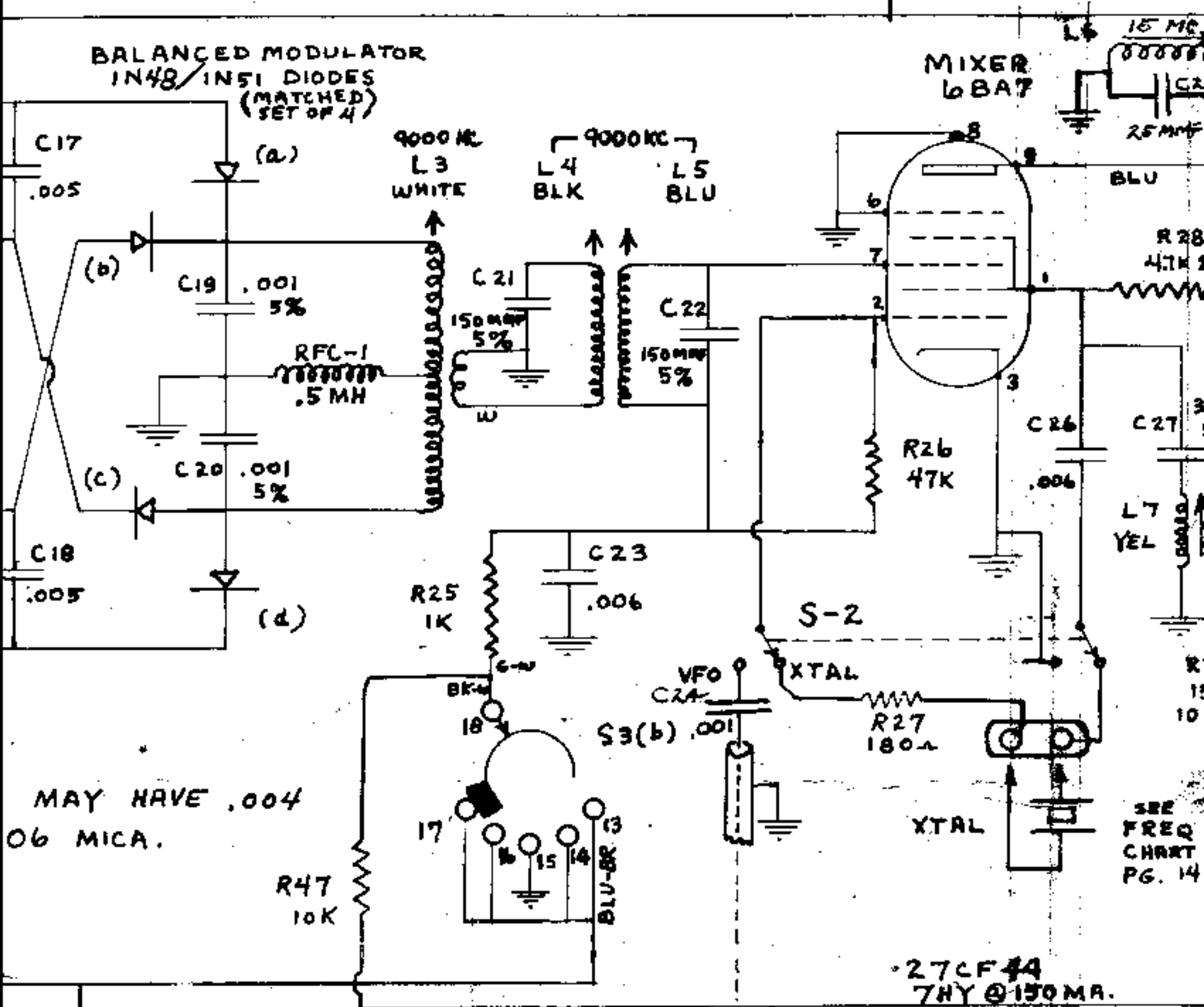

MAY HAVE .004
 06 MICA.

SEE
 FREQ
 CHART
 PG. 14

27CF44
 7HY @ 150 MA.

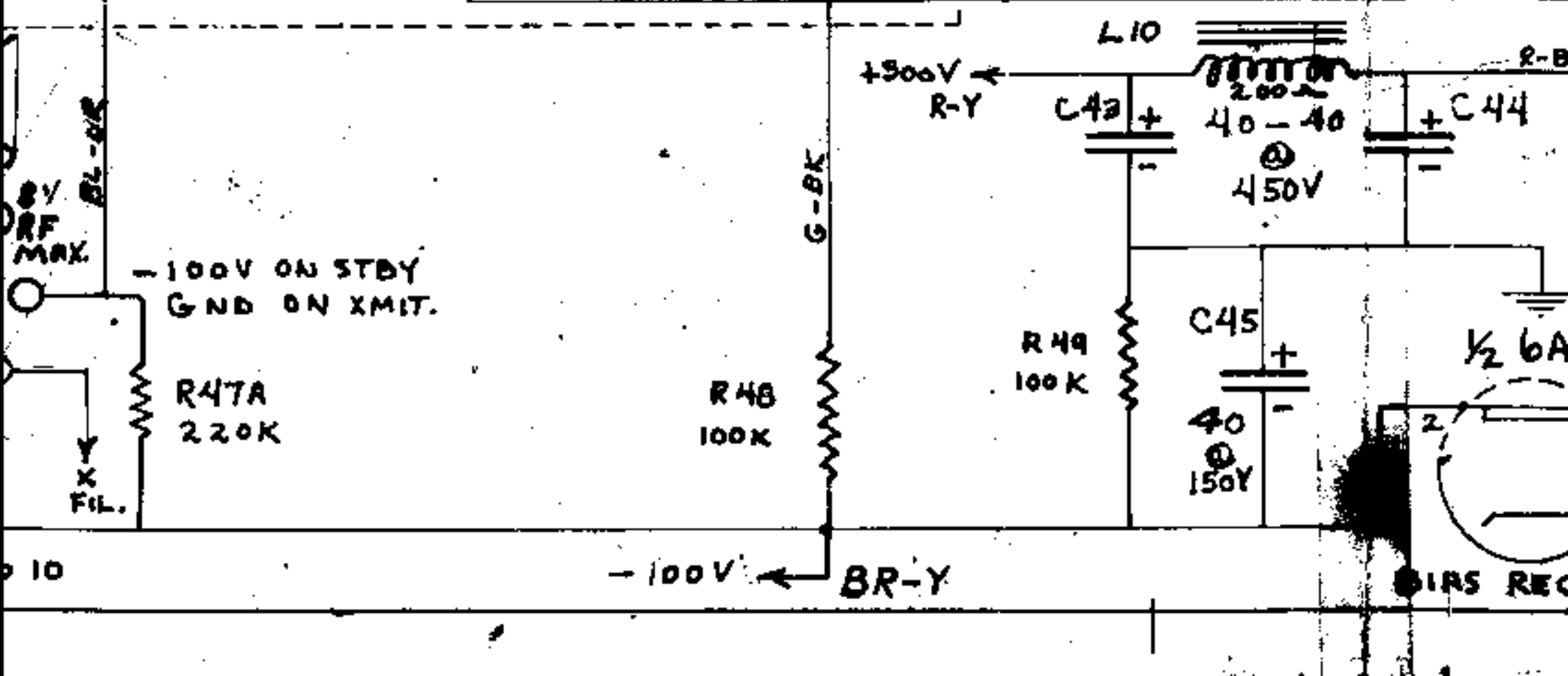

-100V ON STBY
 GND ON XMIT.

-100V

+500V

450V

40
 150V

1/2 6A

BIAS REC

MODULATION
SELECTOR

MASTER OSC
1/2 12BH7

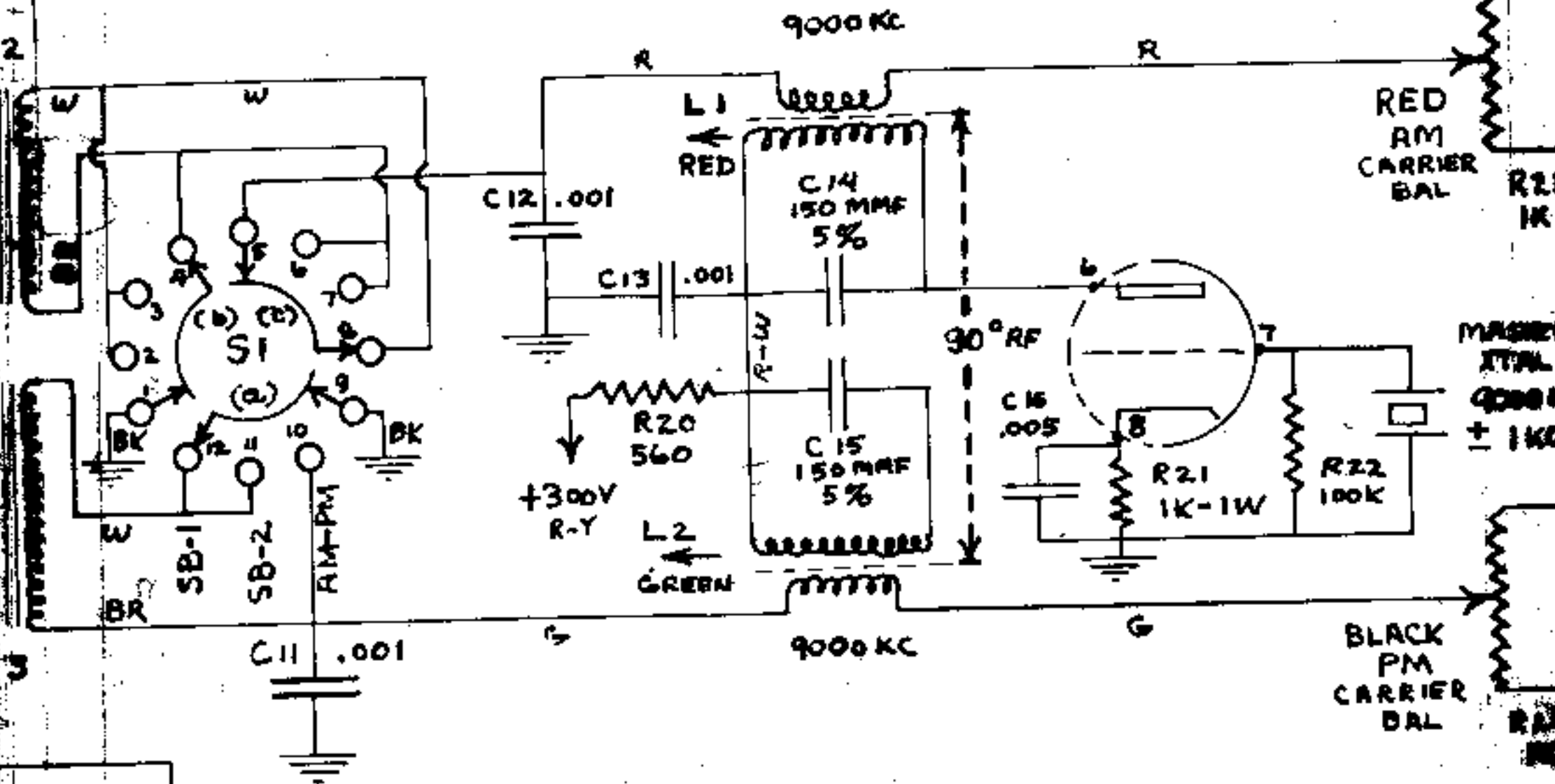

K = X 1000 OHMS
M = MEG OHMS

SOME UNITS
IN LIEU OF

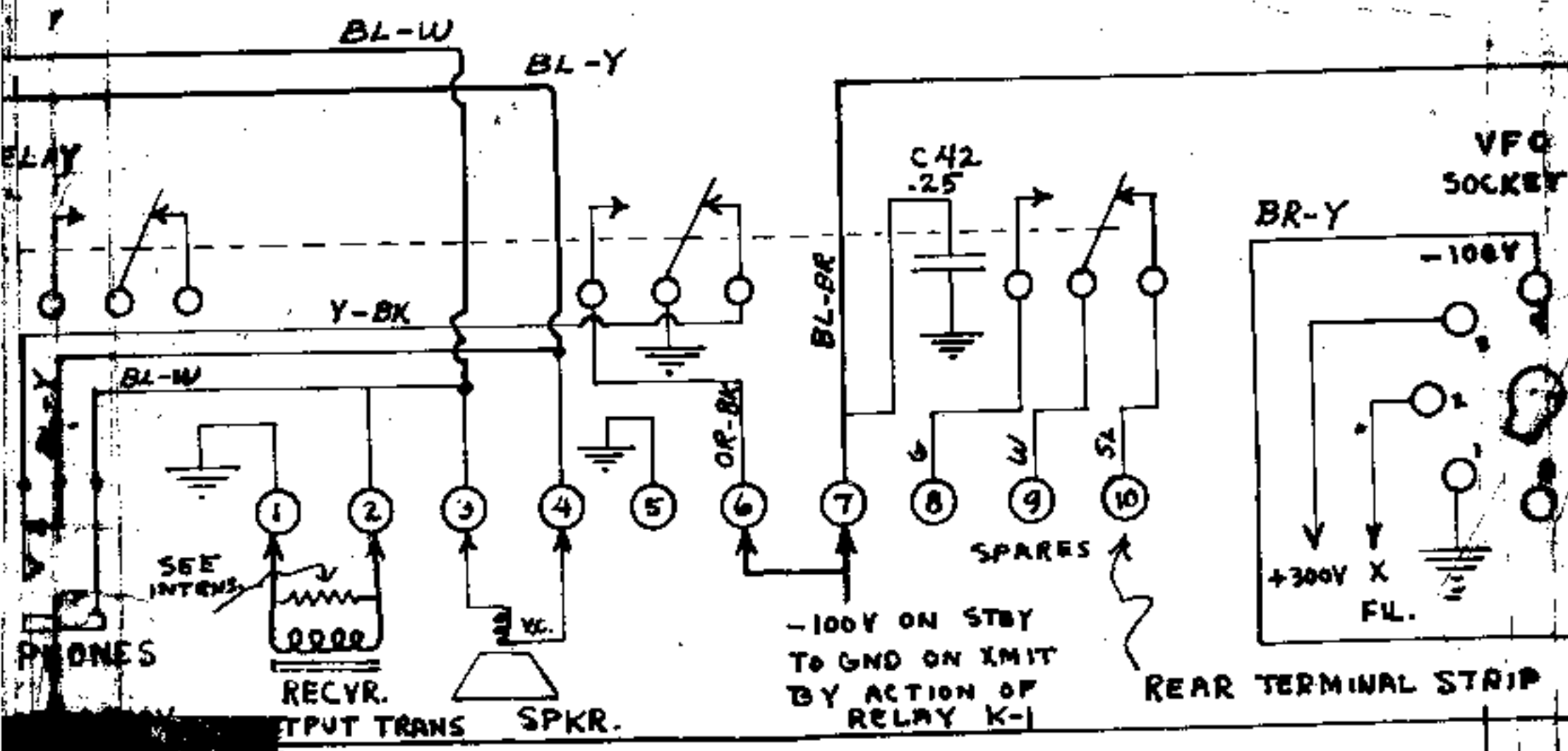

AF DRIVER
1/2 12 BH7

DRIVER TRANS
BK

PS - 1

AF MODULATOR
12 AT7

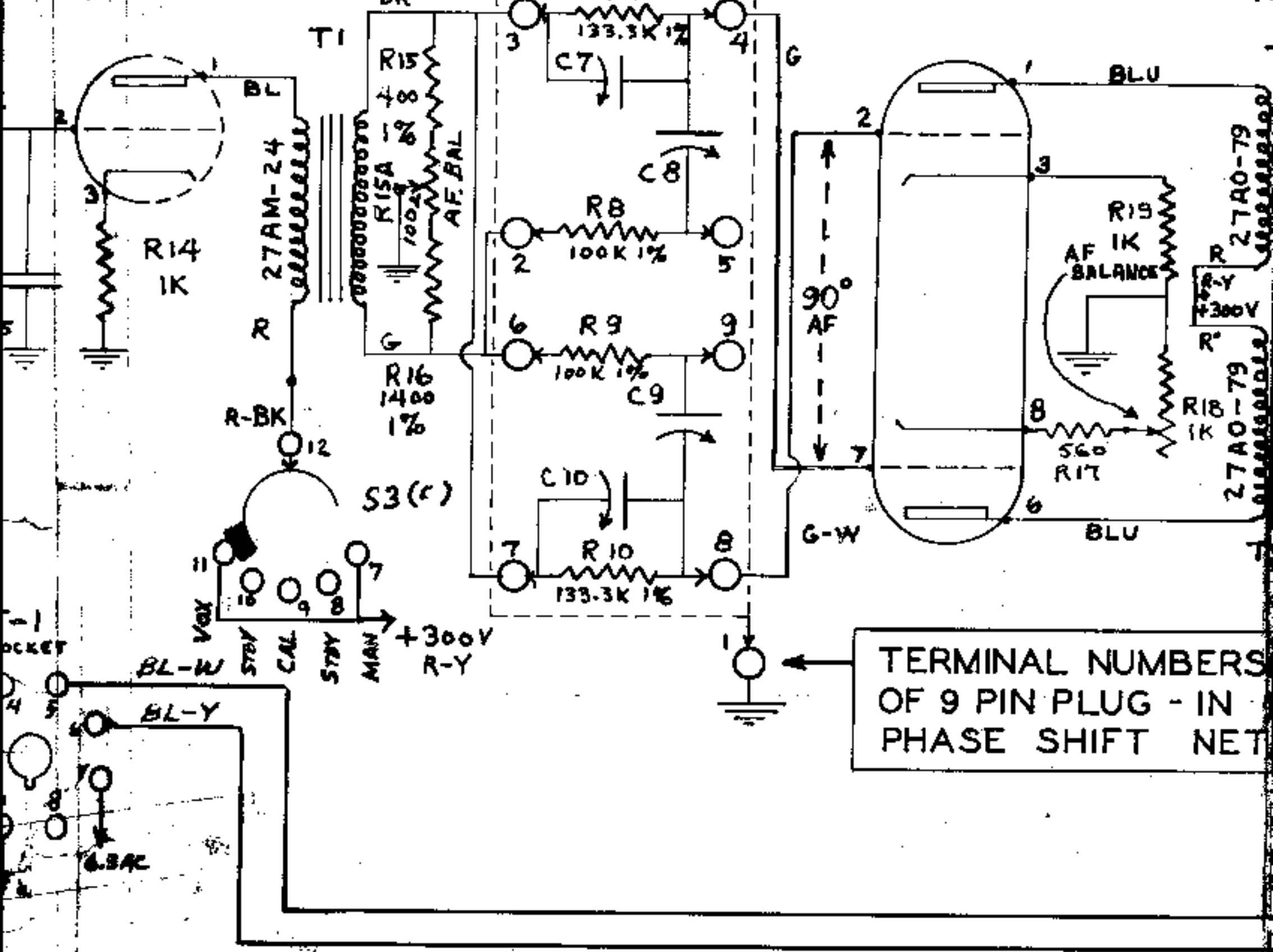

TERMINAL NUMBERS OF 9 PIN PLUG - IN PHASE SHIFT NET

RELAY CONTROL
RECTOR S3 (a, b, c)

RELAY CONTROL
1/2 12AX7 (b)

3PDT RELAY
10000 OHM COIL

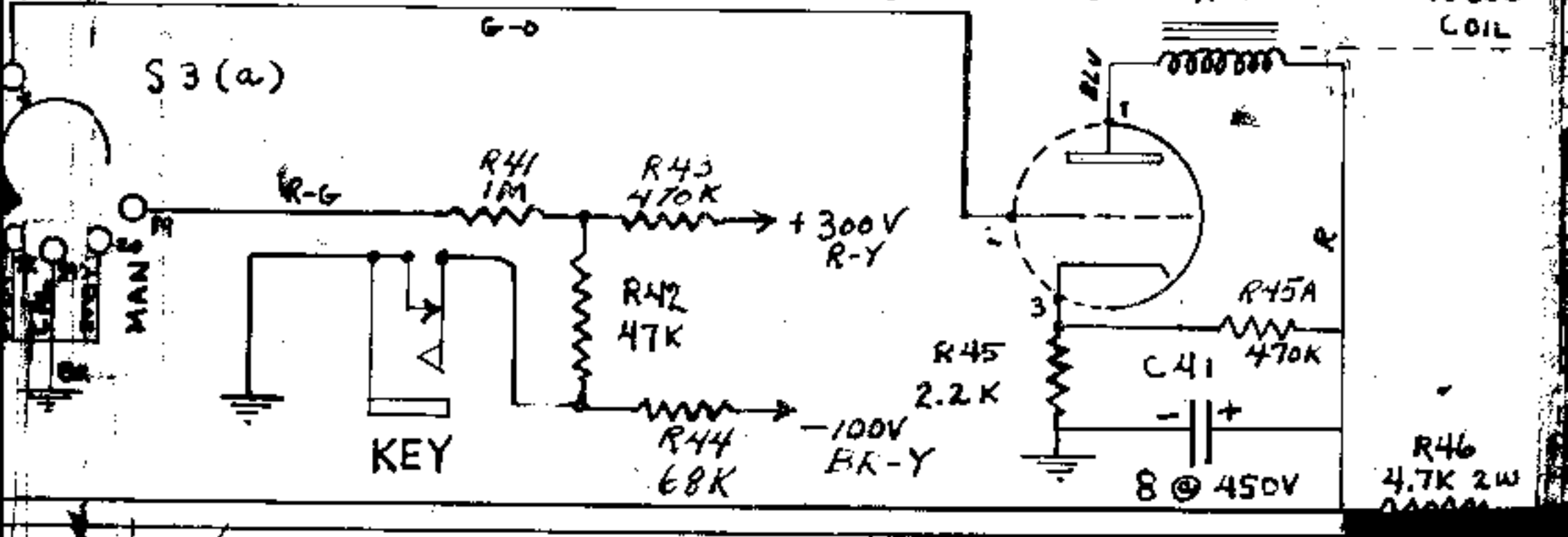

PRE - AMP
12AX7 (2)

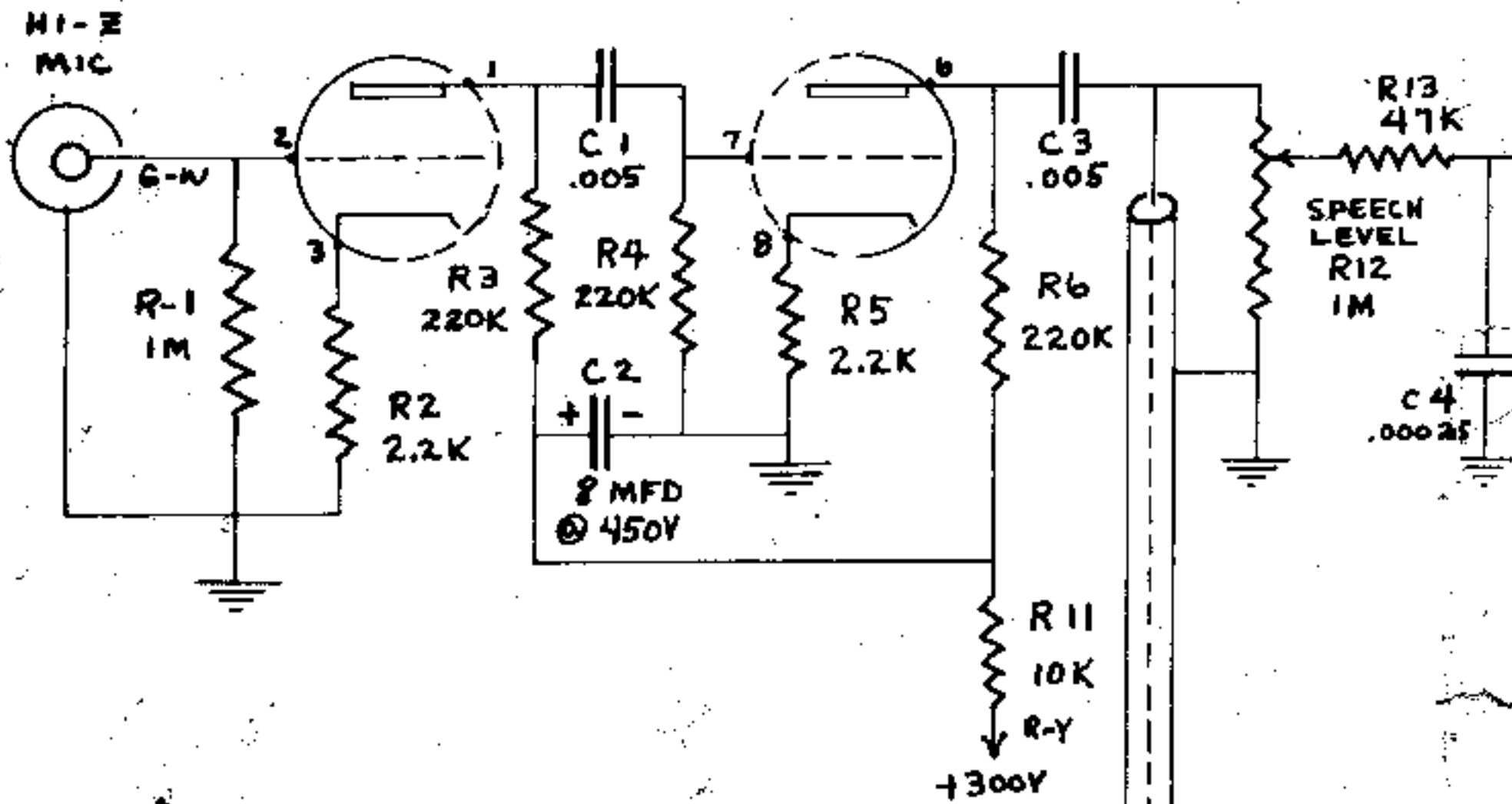

VOICE AMP
1/2 12AX7 (b)

VOICE RECT.
1/2 6AL5

